



KTSB-2040-24-1-TP	
Ballast Type	Magnetic
Starting Method	Rapid Start
Lamp Connection	Series
Input Voltage	120Vac +5% -10%
Input Frequency	60Hz

ELECTRICAL SPECIFICATIONS:

Lamp Type	No. of Lamp	Lamp Footage	Input Watts	Input Current (Amps)	Power Factor	Crest Factor	Ballast Factor	Ballast Efficacy Factor	Max. THD %
F120T12/HO	2	20	255	2.7	0.80	1.8	0.86	0.38	25
F120T12/HO	3	30	350	3.1	0.95	1.8	0.82	0.26	10
F120T12/HO	4	40	470	4	0.98	1.7	0.8	0.19	15

PERFORMANCE:

- Minimum Starting Temperature: -20°F
- Maximum Ballast Case Temperature: 194°F, 90°C
- OCV: 810V
- 3-Year warranty

APPROVALS:

- UL & cUL 935 Listed (Class P, Outdoor, Type 2)
- Thermally Protected

PHYSICAL DIMENSIONS:

Length (L):	19.19"
Width (W):	3.19"
Height (H):	2.69"
Mounting (M):	18.63"

WIRING DIAGRAM:

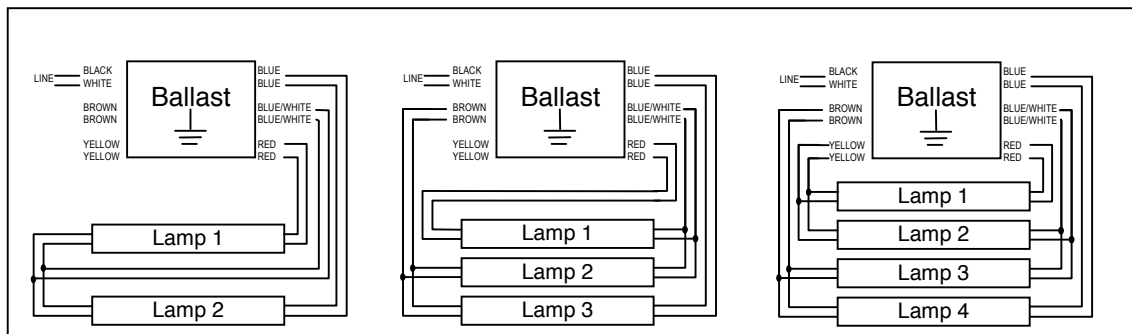

KEYSTONE TECHNOLOGIES LLC.
P.O. Box 246, AMBLER, PENNSYLVANIA 19002
PHONE: 215-283-2600
FAX: 215-628-4412
INFO@KEYSTONEBALLAST.COM
WWW.KEYSTONEBALLAST.COM